

19" wall cabinet from the CH series



General information about the product

The cabinet is designed for the installation of telecommunications, electrical, patch cords and other equipment to 19-inch standard.

The structure of the cabinet is collapsible, consisting of welded blocks: Ceiling and floor, connected by frames, removable panels and doors.



Technical description

Height	9U
Width	600 mm
Depth	450 mm
Color	Black (9005), Gray (7035)
Metal thickness	Guides S = 1 mm, Zinc, Roof, Floor, Side walls and back wall S = 0,5 mm Side frames S = 0,8 mm
Product assembly time	less than 10 minutes
Slide shape	g-like
Door opening angle	120 Degrees
Cable glands	For standard brush seal sizes
Level of protection	IP21
Door types	tempered glass, basic version Perforation, optional application

Installation instructions

Confession	Position	Quantity
Doors	1	1
Back wall	2	1
Base	3	2
Side wall	4	2
Frame	5	2
Rack unit	6	4

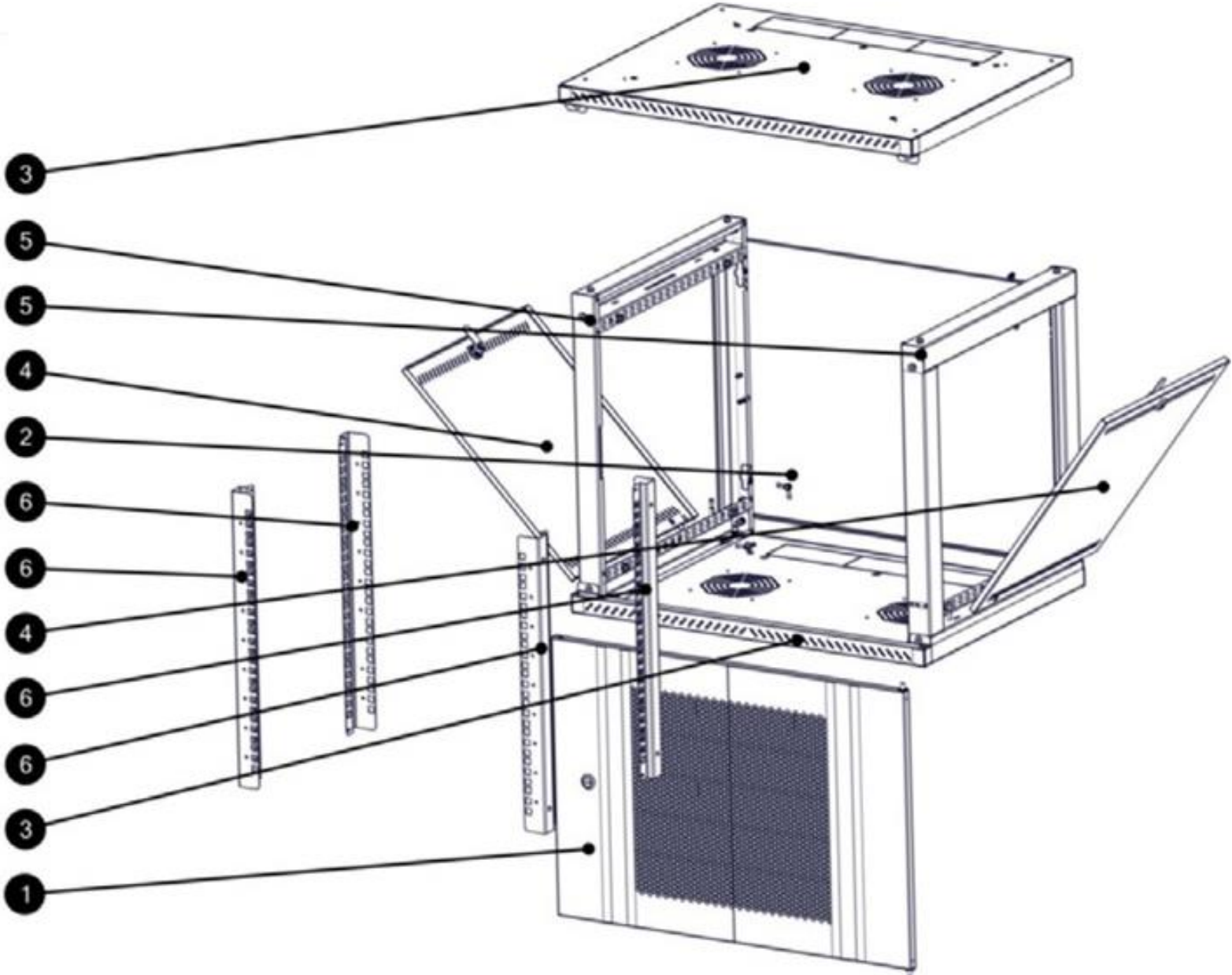

1

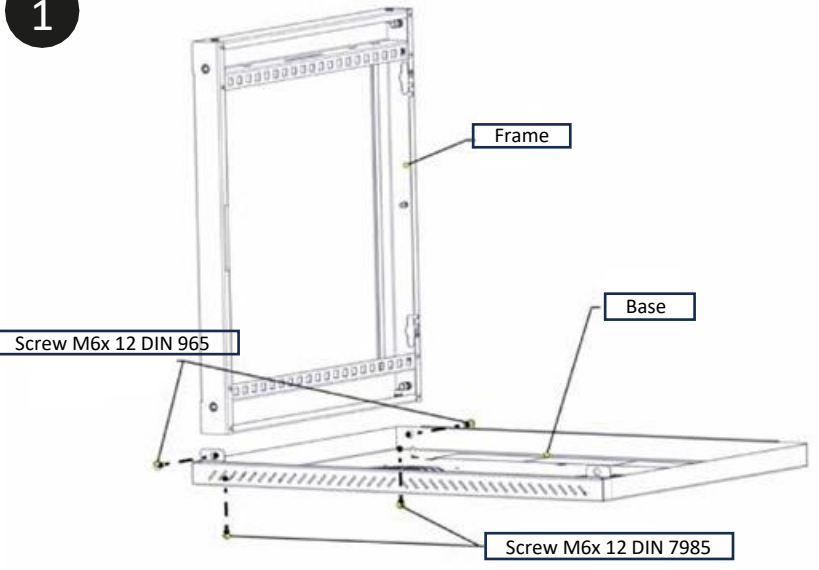

3

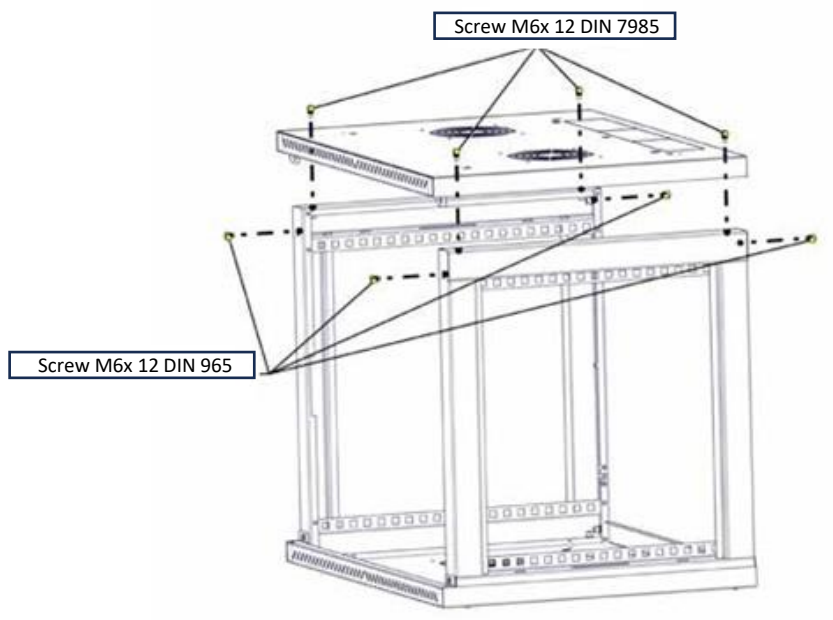

2

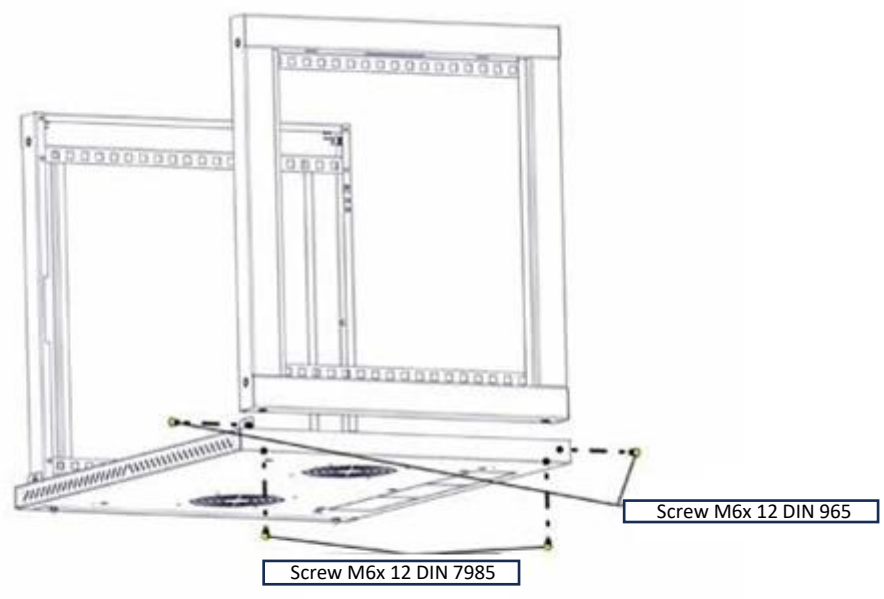

4

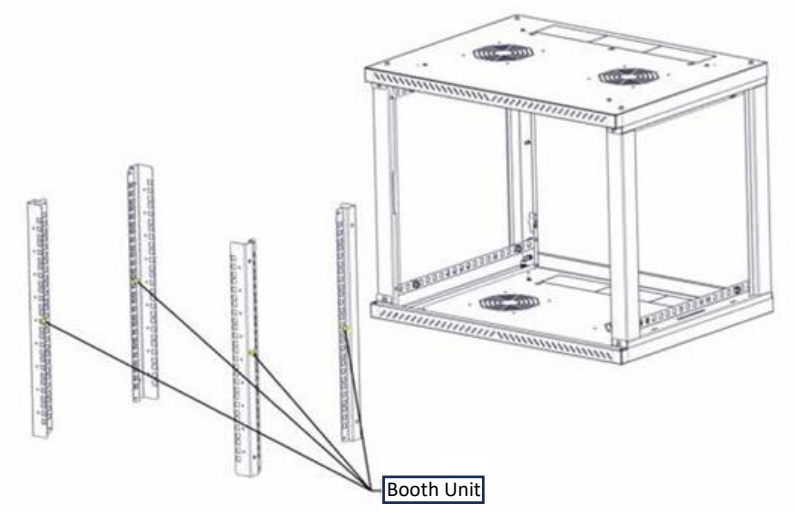

5

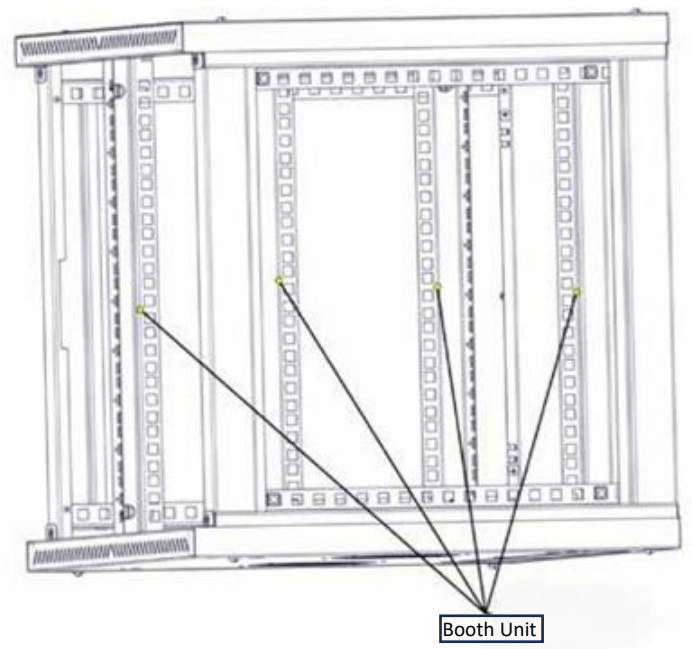

7

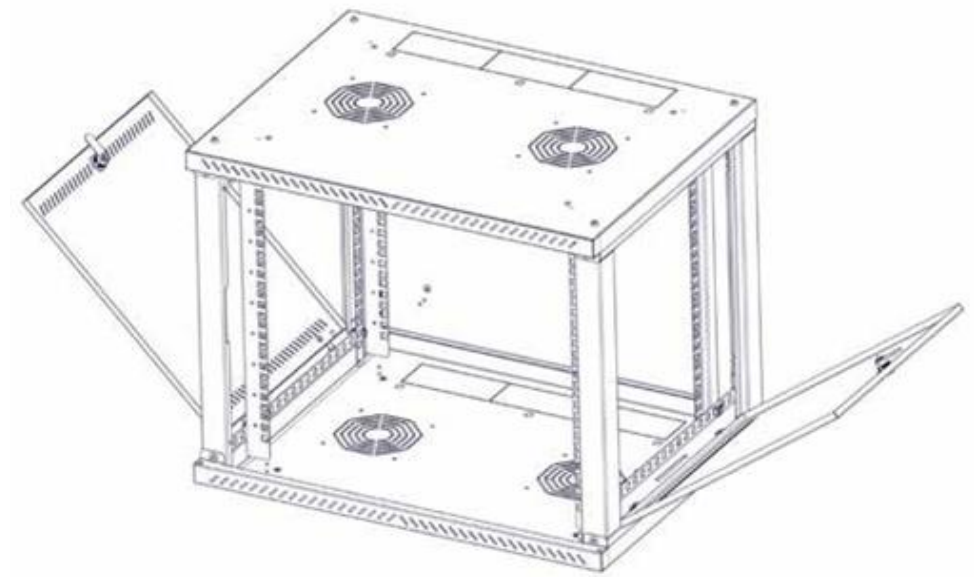

6

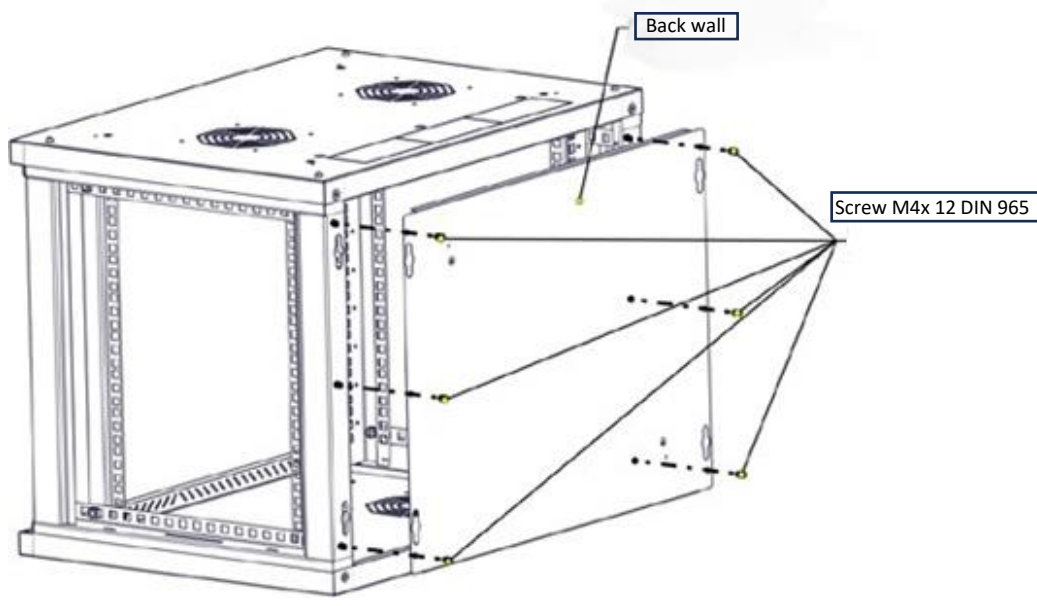

8

